



Version of 03/30/2023

TELIS 9000

Universal input



Universal power supply



Hot-swappable plug in and out



Sensor power supply



ModBus RTU

Presentation

TELIS 9000 is a universal input transmitter with quadruple galvanic isolation, 24-bit conversion for inputs and 16-bit conversion for outputs, and accurate cold junction compensation at $\pm 1^\circ\text{C}$ for thermocouple inputs.

TELIS 9000 is guaranteed for **5 years**

Range

*: 1 universal input or 2 current passive mA inputs with calculation mode

Transmitter with graphic display	Input*	Outputs						Communication	Case width (mm)		Transmitter without graphic display
		Number of Analog		Number of Relay					RS485 USB	22.5	
		1	2	1	2	3	4				
TELIS 9000U0	✓							✓	✓		TELIS 9000T0
TELIS 9000U1	✓	✓						✓	✓		TELIS 9000T1
TELIS 9000U2	✓		✓					✓	✓		TELIS 9000T2
TELIS 9100U0	✓			✓				✓	✓		TELIS 9100T0
TELIS 9150U1	✓	✓		✓				✓	✓		TELIS 9150T1
TELIS 9250U0	✓				✓			✓	✓		TELIS 9250T0
TELIS 9200U0	✓				✓			✓		✓	TELIS 9200T0
TELIS 9200U1	✓	✓			✓			✓		✓	TELIS 9200T1
TELIS 9200U2	✓		✓		✓			✓		✓	TELIS 9200T2
TELIS 9300U0	✓					✓		✓		✓	TELIS 9300T0
TELIS 9300U1	✓	✓				✓		✓		✓	TELIS 9300T1
TELIS 9400U0	✓						✓	✓		✓	TELIS 9400T0
TELIS 9400U1	✓	✓					✓	✓		✓	TELIS 9400T1
TELIS 9400U2	✓		✓				✓	✓		✓	TELIS 9400T2

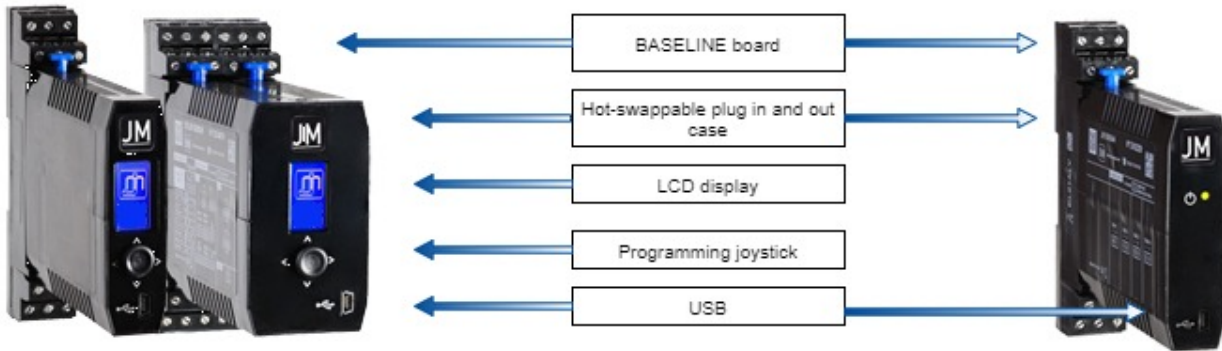

Factory settings

Input	Output 1 & 2	Relays (1 RT or 1T)
4-20mA	4-20mA	Alarm: High
Display: 0-100		Threshold: 50

Communication speed: 9600 bauds, Slave address: n°1

Other settings on demand

Inputs - Outputs

Input gauges

Current (continuous)	Standard scales: 0-1mA ; 0-10mA ; 0-20mA ; 4-20mA ; ±1mA ; ±10mA ; ±20mA Adjustable scales: from -22 to 22mA
Voltage (continuous)	Standard scales: 0-100mV ; 0-1V ; 0-5V ; 1-5V ; 0-10V ; 2-10V ; ±100mV ; ±1V ; ±5V ; ±10V Standard scales: 0-50V ; 0-100V ; 0-200V ; 0-500V ; 0-1000V ; ±50V ; ±100V ; ±200V ; ±500V ; ±1000V Adjustable scales: From -110 to 110mV, from -2 to 11V Adjustable scales: From -1000 to 1000V
Variable resistance thermometer	Standard scales: CU50 ; CU53 ; CU100 PT10 ; PT100 ; PT1000 ; Ni100 ; Ni1000 2 or 3 wires Adjustable scales: CU50 ; CU53 ; CU100 PT10 ; PT100 ; PT1000 ; Ni100 ; Ni1000 2 or 3 wires
Resistance 2 wires	Standard scales: 200Ω ; 1KΩ ; 10KΩ ; 50KΩ
Special table for NTC PTC	Adjustable scales: 200Ω ; 1KΩ ; 10KΩ ; 50KΩ Programmable with IXLOG software Unit: °C or °F
Thermocouple	Standard scales: J, K, R, S, T, E, B, N, W3/D, W5/C, Mo, P Adjustable scales: J, K, R, S, T, E, B, N, W3/D, W5/C, Mo, P Unit: °C or °F Cold junction compensation: internal or external
Potentiometer	From 0-100Ω to 0-100KΩ Other values on request
Sensor supply	2 or 3 wires sensor 24V - 32mA max Only in 1 channel input mode

Output gauges

Output Current 1 & 2	Standard scales: 0-10mA ; 0-20mA ; 4-20mA Adjustable scales: from 0 to 20mA
Output Voltage 1	Standard scales: 0-10V ; ±10V (except TELIS 9150X1 and TELIS 9300X1) ; 0-5V ; 1-5V ; 2-10V Adjustable scales: from -10 to 10V (except TELIS 9150X1 and TELIS 9300X1)
Output Voltage 2	Standard scales: 0-5V ; 1-5V ; 2-10V ; 0-10V Adjustable scales: from 0 à 10V
Output Relay	Relay 1RT or 1T: 2A-250Vac
Communication	Isolated USB in Front Panel / Isolated RS485 Modbus RTU

Characteristics

Display	
Type	Backlit LCD
Color	Blue
Number of characters	5
Numbers of lines	5
Programming joystick	5 positions
Input characteristics	
Current input impedance	5.6Ω
Voltage input impedance	U<10V: >10MΩ U±10V ou >10V: 6MΩ
Current input PT100 ; Ni100	Current: <1mA
Current input PT1000 ; Ni1000	Current: <0.8mA
Current input resistance 2 wires R=200Ω ; R=1kΩ	Current: <1mA
Current input resistance 2 wires R=10kΩ	Current: <0.2mA
Output characteristics	
Permissible impedance on the current output	Output 1 & 2: <1kΩ
Permissible impedance on the voltage output	Output 1 & 2: >1kΩ
Isolation	
Supply / Input-Output(s)-Relay- RS485-USB	4200Vrms, 50Hz, 1mn
Input / Output 1 / Output 2 / Relay / RS485	2500Vrms, 50Hz, 1mn
USB / Input	2500Vrms, 50Hz, 1mn
USB / Output 2	Without
USB / Output 1-relay	2500Vrms, 50Hz, 1mn
USB / RS485	2500Vrms, 50Hz, 1mn
Auxiliary source	
Voltage supply	22-240Vdc or 90-230Vac 50/60Hz

General characteristics	
Precision class	0.1
Input analog / digital conversion	24 bits
Output analog / digital conversion	16 bits
Response time	Process input, Thermocouple, 2 wires resistor: <80ms RTD potentiometer: <160ms
Thermal drift	<25ppm
Residual ripple on current output	<20µA
Residual ripple on voltage output	<10mV
Maximum of consumption	<10VA
Operating temperature	-10°C ... +60°C
Storage temperature	-25°C ... +80°C
Protection factor	IP20 Black self-extinguishing polyamide housing V0

Options listing

Option	Device code
Tropicalization for 22,5mm or 45mm cases	TELIS 9XXXXX-T
Auxiliary source 22-60Vac	TELIS 9XX9XX
Passive output only on the calibre 4-20mA Permissible voltage on the passive output: 15V<U<36V	TELIS 9XXXXX-PAS11 (output 1 passive) TELIS 9XXXXX-PAS12 (output 2 passive) TELIS 9XXXXX-PAS22 (2 passive outputs)

Functions

Display functions	
LCD display	Graphic display by LCD screen
LED indicators	1 green LED on devices without display
5 positions joystick	Allows you to configure the parameters displayed on the front panel screen
Programming lock	Locking of the programming on the front panel or by the IXLOG software Unlock by long press on the joystick
Programming	Programming via joystick on the front panel, or via USB with IXLOG software
Memory Mini / Maxi	Storage of the maximum and minimum value of the measurement on each input channel
Customizing the display	Resolution, Comma, Contrast adjustment, Display off
Input	
Inputs display	The display allows to visualize the input in physical value and in programmed value
Adjustable input scale	Allows to zoom on the input either in manual or automatic mode
Offset	Manual adjustment of the input offset
Taring	Taring function at process input (by validation)
Cut-off	Threshold below which the input is considered as null

Smart functions	
Sensor signal loss	Translates the sensor signal loss on: <ul style="list-style-type: none"> • the display, • each of the analog outputs, • the digital output, • the status of the relays
Filtering	Integration of the measurement over the defined time (in seconds)
Calculation mode	Rule calculation (+, -, x, /), result on input 3
Square root	The output(s) are function of the square root of the input
Absolute value	The output(s) are a function of the absolute value of a bidirectional input
Pilot function/simulation	The pilot function makes it possible to act on the display value influencing the output(s), independently of the input The Pilot function is activated either by the digital link (RS485 or USB) or by the joystick on the front panel
Segmentation in 99 points	Linearization in 99 points (free choice for each point), allows to create an output function by segmentation of the signal of each input channel
Segmentation PTC-NTC resistive	Allows to create the PTC or NTC curve by segmentation of the input signal (programmable only by the IXLOG software)
CJC	Cold junction compensation by 16 bit digital sensor
Outputs	
Visualization of the outputs	The display allows to visualize the outputs, in physical value and percentage; as well as the status of the relays
Output assignment	Assignment of outputs to inputs or to the control function, independently for each channel
Adjustable output scale	Allows you to zoom in on the outputs
Output limitation	Possibility to limit the value of the outputs - High limit and Low limit
Relay assignment	Assignment of relays to inputs or to the control function, independently for each channel
Thresholds	Single or band mode, with positive or negative safety Adjustment of thresholds, hysteresis and time delay (independent on rise or fall) Direct access to the thresholds
Acknowledgement of alarms	Independently for each alarm
Storage of alarms and/or relay status	Independently for each alarm

Links and communication	
RS485 MODBUS RTU	RS485 MODBUS RTU bidirectional digital link allowing to: <ul style="list-style-type: none">• recover the measurements and transmit them in digital format• configure and control the device
Digital bus	Access to the digital bus via the USB socket (when transmitters are used on the interface boards)
USB front	USB front panel to connect directly to the USB port of a PC for programming via the IXLOG software
Mapping of Modbus addresses	Mapping of Modbus addresses, allowing you to choose your own variable address

Dimensions and wiring

Dimensions

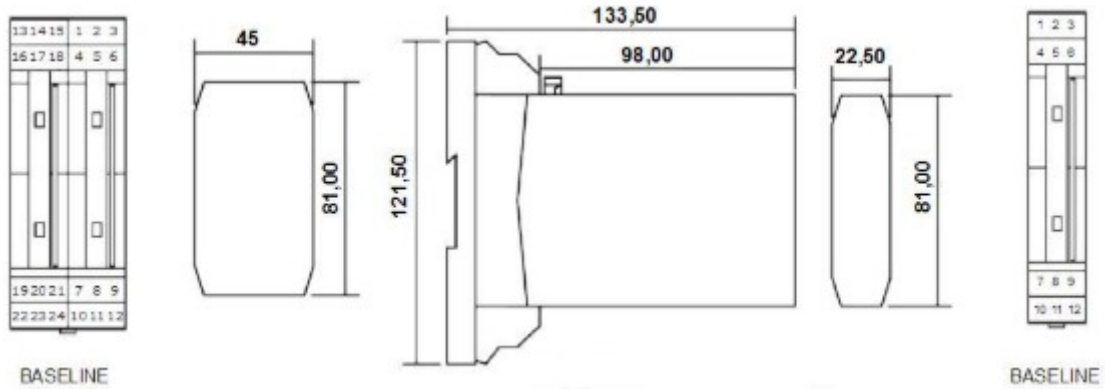

Dimensions: Width : 22.5 or 45 mm - Height: 81 mm - Depth: 98 mm

- ⓘ BASELINE boards are to be ordered separately
22.5 mm Case: Reference BL01ALV ; 45 mm Case: Reference BL02ALV
For multi-transmitter boards, please consult us.

Wiring

TELIS 9000U0

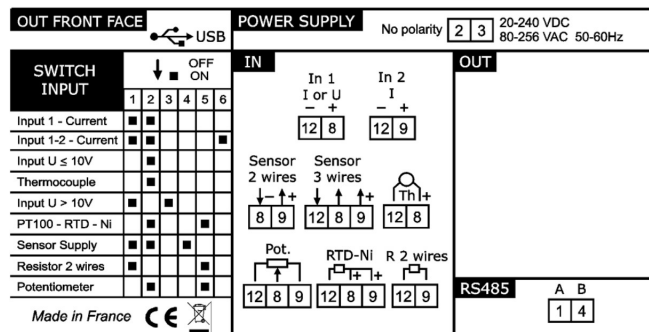

TELIS 9000U1

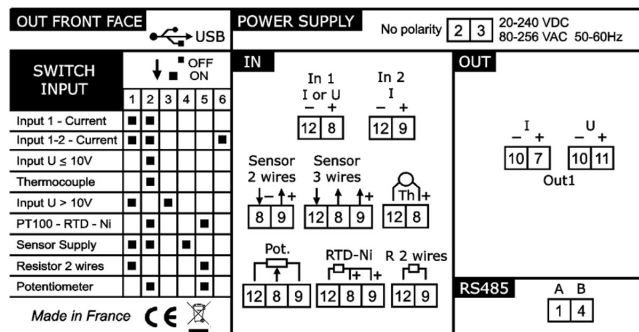

TELIS 9000U2

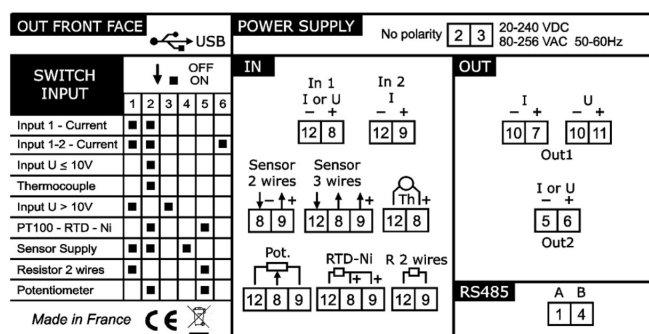

TELIS 9100U0

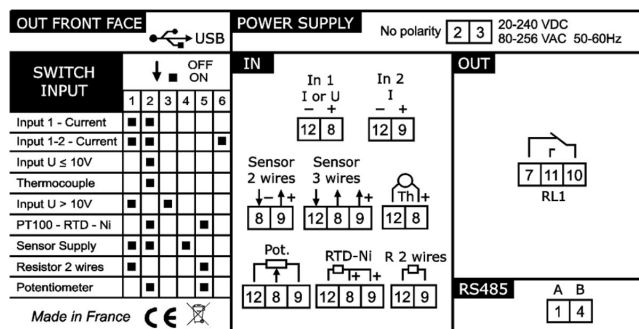

TELIS 9150U1

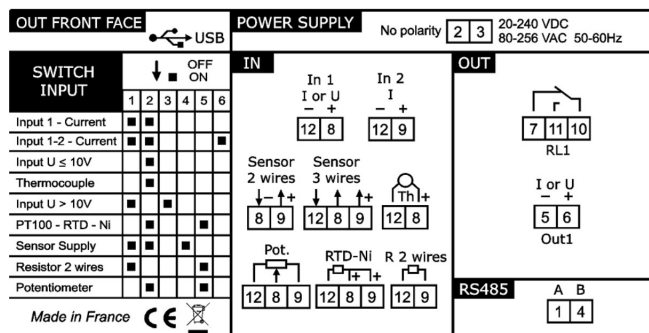

TELIS9200U0

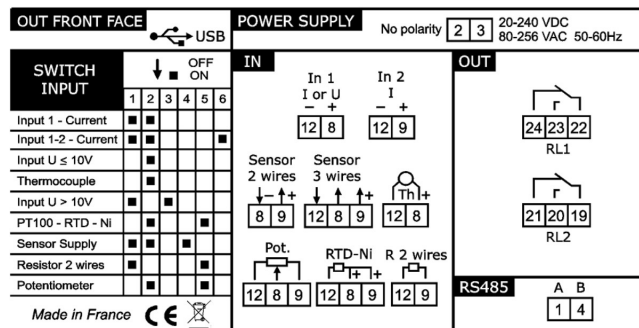

TELIS 9200U1

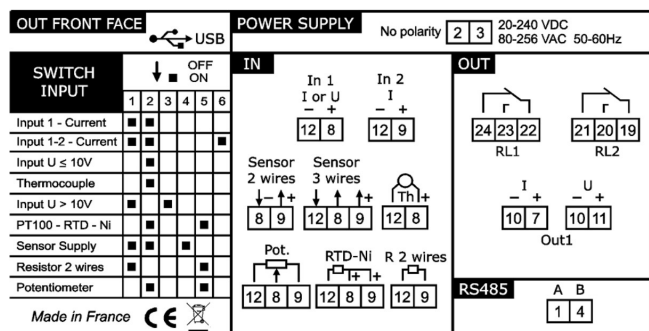

TELIS9200U2

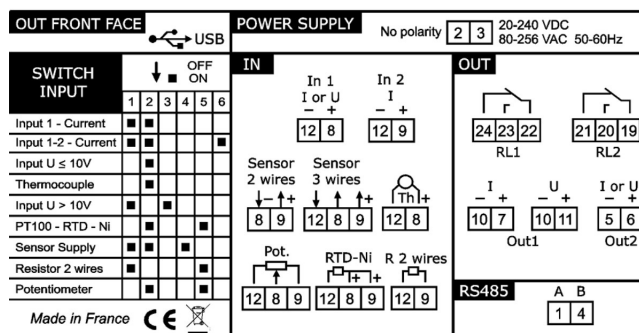

TELIS 9250U0

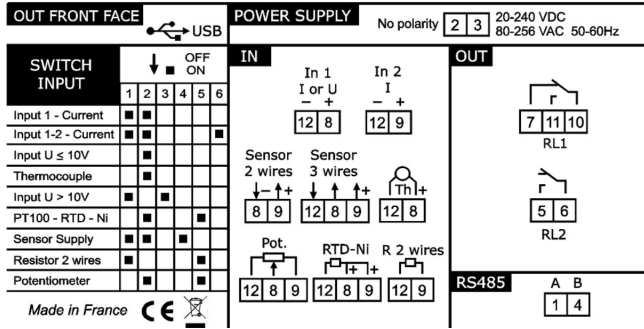

TELIS 9300U0

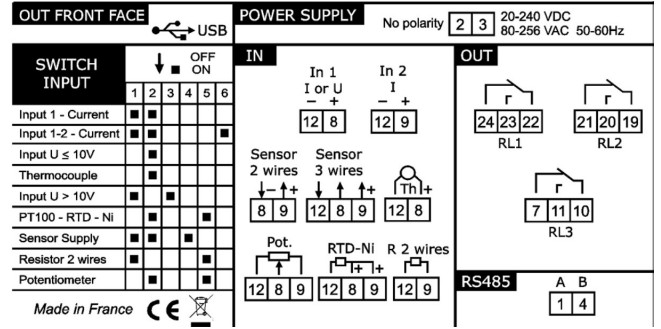

TELIS 9300U1

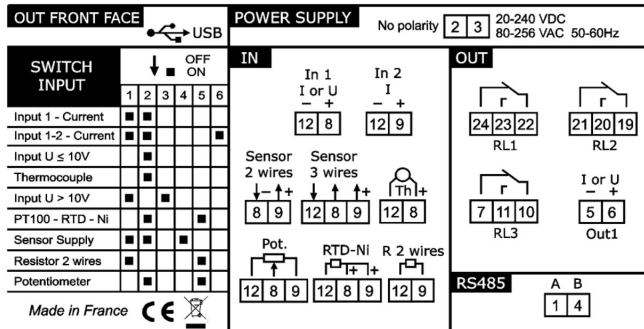

TELIS 9400U0

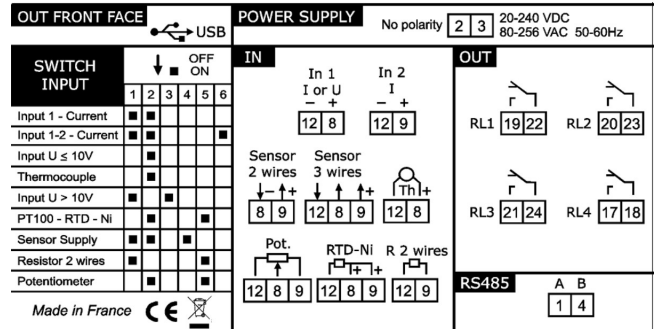

TELIS 9400U1

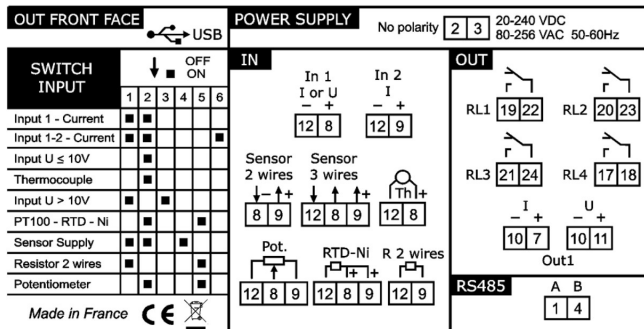

TELIS 9400U2

